

# AdvanReader-150™

## 2 or 4-port RFID UHF reader with on-board computer and open Linux OS



### Product overview

**AdvanReader-150** is a high power (31.5 dBm), high performance UHF reader with an on-board microcomputer and a fully open Linux operating system.

AdvanReader-150 comes with **two models**:

- **2-port, 30 dBm** power output
- **4-port, 31.5 dBm** power output

Thanks to its on-board microcomputer, AdvanReader-150 can work **stand-alone**, without needing to be connected to an external computer, thereby reducing equipment costs, installation costs, and maintenance costs.

AdvanReader-150 is prepared to work with **batteries** and control the battery level. It has a sleep mode for minimizing consumption. It is therefore ideal for mobile systems.



### Benefits:

- High-performance: high output power and high sensitivity
- Highest flexibility: on-board microcomputer
- Fully open Linux OS
- Reduces time and cost of developing RFID systems
- You can make it your own reader by putting your company logo on the enclosure
- Can control up to 1024 antennas by using it in combination with AdvanMux multiplexer
- Direct connection to an external loudspeaker
- 2 digital/analog inputs.
- 8 digital outputs

### Applications:

- Smart shelves
- Smart display fixtures
- Smart surfaces
- RFID portals
- RFID tunnels
- Point of Sales
- Loss prevention systems
- In general, any RFID application

### Additional product features

AdvanReader-150 can become **your own reader**: your company logo can be the only logo on the enclosure.

A single AdvanReader-150 unit **can control up to 1024 antennas** when connected to Keonn multiplexers.

AdvanReader-150 can also be connected to AdvanPhaser (phase shifter) in order to **control electronically the beam orientation of directive antennas**, which allows to obtain higher read-rate.

AdvanReader-150 is also very flexible in terms of **inputs and outputs**:

- 2 x digital/analog inputs
- Direct LED connections
- 4 x digital outputs (higher power):
- 4 x digital outputs (low power):
- Loudspeaker: 8 ohm/2 W
- 2 x RJ45 to directly connect to other Keonn devices, such as AdvanMux and AdvanPhaser

AdvanReader-150 includes several **sensors, actuators and indicators** on-board:

- Aux Power Supply Voltage
- PoE Power Supply Temperature
- Aux Power Supply Temperature
- Ambient Temperature (only under special request)
- On-board buzzer
- On-board LED indicators for: power on, Ethernet linked, Ethernet activity, serial data in, serial data out, digital output lines, digital input lines, etc.

# AdvanReader-150™

## 2 or 4-port RFID UHF reader with on-board computer and open Linux OS



### RF Specifications:

Air Protocol Interface	EPC global UHF Class 1 Gen 2 / ISO 18000-6C
Supported regions	FCC (NA, SA) 902 MHz - 928 MHz
	ETSI (EU, IN) 865.6 MHz - 867.6 MHz
	MIC (KR) 910 MHz - 914 MHz
	SRRC-MII (P.R.China) 920 MHz - 925 MHz
	Brazil: 902-907,5 MHz and 915-928 MHz (by using channel selection)
	Israel 915.0 - 917.0 MHz1
	Japan 916.8 - 920.8 MHz2
RF connections	Chile 916 – 928 MHz (by using channel selection)
	Peru 916 – 928 MHz (by using channel selection)
	Taiwan 922 – 928 MHz (by using channel selection)
	ACMA (AU, NZ) 920 MHz – 926 MHz
	Open región
	Four 50 ohm SMA connectors for monostatic antennas (4-port version) Two 50 ohm SMA connectors for monostatic antennas (2-port version)
RF Power	4-port version: Programmable from 5 dBm to 31.5 dBm in 0.5 dBm steps 2-port version: Programmable from 0 dBm to 30 dBm in 0.5 dBm steps (Maximum power may have to be reduced to meet regulatory limits)
Max tag read distance	Up to 9 m (33 feet) with 6dBi gain antennas (4-port model)
Max tag read throughput	Up to 400 tags/second (4-port model) Up to 100 tags/second (2-port model)

### Software Specifications:

On-board intelligence	BCM (Battery Controller Module)
	<ul style="list-style-type: none"> <li>• MSP430 firmware</li> <li>• Automatic battery protection</li> <li>• Configurable scheduler for active/sleep mode</li> </ul>
Battery control module	ARM board
	<ul style="list-style-type: none"> <li>• Cortex A-8 CPU (1 GHz)</li> <li>• 512 MB RAM</li> <li>• 4 GByte ROM with Operating System</li> <li>• 1 x USB connector</li> </ul>
On-board software	MSP430 firmware
	Automatic battery protection Configurable scheduler for active/sleep mode
External software development	AdvanNet-2.3: advanced driver platform for Keonn components and systems
	Debian Squeeze (Debian 7.8) based distribution
Internal development environments	AdvanNet based:
	<ul style="list-style-type: none"> <li>• Test and deploy web-based GUI utility (AdvanNet Monitor)</li> <li>• REST interface that can be used in any development environment</li> </ul>
Operating system	Java development C development
	The OS is fully open

# AdvanReader-150™

## 2 or 4-port RFID UHF reader with on-board computer and open Linux OS



### Electrical, communication and mechanical specifications:

Data communications	<p>Ethernet: IEEE 802.3 up to 100 Mbps</p> <p>USB HID (USB Type-B connector)</p> <ul style="list-style-type: none"> <li>• USB HID hardware emulation</li> </ul> <p>Wi-Fi through a USB dongle: RTL8192CU chipset is supported by default. Wi-Fi USB dongle not included</p>
Other ports	<p>HDMI port and Micro SD slot (maintenance only ports)</p> <p>USB (Type-A) Host</p> <ul style="list-style-type: none"> <li>• Accepts USB memory sticks</li> <li>• Accepts USB Wi-Fi dongle</li> </ul>
Power supply	<p>Power Over Ethernet (PoE): IEEE 802.3af and 802.3at (Type 1 &amp; Type 2)</p> <p>Power supply: 11 V (DC) @ 2 A to 24 V (DC) @ 1 A</p> <p>On-board battery for RTC chip (CR2032)</p>
Battery Operation	<p>The system is specifically designed for battery assisted operation.</p> <ul style="list-style-type: none"> <li>• Protects lead batteries by disconnecting the system when the battery level is below a threshold</li> <li>• Scheduler to activate/deactivate the system</li> <li>• Very low consumption in sleep mode: &lt; 160 uA</li> </ul>
Output power	<p>5 V @ 100 mA non-isolated power supply to feed external devices and circuitry</p>
On-board sensors and actuators	<p>Buzzer</p> <p>Aux Power Supply Voltage</p> <p>Aux Power Supply Temperature</p> <p>5 Vcc Voltage</p> <p>Power consumption</p> <p>IN1 Voltage</p> <p>IN2 Voltage</p> <p>RTC chip to keep Date&amp;Time between reboots. Battery life time more than 10 years in power off mode.</p>
On-board LED indicators	<p>LED ON (Blue LED)</p> <p>LED status (Orange LED)</p> <p>LED M6e Rx line (Green LED)</p> <p>LED M6e Tx line (Red LED)</p> <p>LED Micro Status (Green LED)</p>
Inputs	<p>2 x digital input (IN3 and IN4)</p> <ul style="list-style-type: none"> <li>• Non isolated</li> <li>• 0 VDC to 30 V (DC)</li> </ul> <p>2 x digital/analog inputs, 10 bits resolution</p> <p>Inputs accepted in the range:</p> <ul style="list-style-type: none"> <li>• 0 V – 3 V (Input 1)</li> <li>• 0 V – 10 V (Input 2)</li> </ul>
Outputs	<p>Direct LED connections :</p> <ul style="list-style-type: none"> <li>• Power on LED</li> <li>• Ethernet link LED</li> <li>• Ethernet activity LED</li> </ul> <p>4 x digital outputs (higher power):</p> <ul style="list-style-type: none"> <li>• Non isolated</li> <li>• Maximum output current 100mA</li> </ul> <p>4 x digital outputs (low power):</p> <ul style="list-style-type: none"> <li>• Non isolated</li> <li>• Maximum output current 8 mA</li> </ul> <p>1 x relay output</p> <ul style="list-style-type: none"> <li>• OUT6</li> <li>• Powered by OMRON G5V-1 5DC</li> <li>• Usage <ul style="list-style-type: none"> <li>• 24 VDC / 0.5 A / Resistive load</li> </ul> </li> </ul> <p>Other outputs :</p> <ul style="list-style-type: none"> <li>• Loudspeaker: 8 ohm/2 W</li> <li>• 2 x RJ45 to directly connect to other Keonn devices, such as AdvanMux and AdvanPhaser</li> </ul>
Power consumption	<p>Idle consumption &lt; 3 W</p> <p>Max consumption (@31.5 dBm) &lt; 14 W</p>
Temperature	<p>-20 °C to +40 °C</p>
Size	<p>Without enclosure: 222 mm x 146 mm x 24 mm (8.74 in x 5.79 in x 0.95 in)</p> <p>With enclosure: 214 mm x 142.5 x 28 mm (8.42 in x 5.61 in x 1.1 in)</p>
Weight	<p>Without enclosure: 280 g (9.9 oz)</p> <p>With enclosure: 620 g (21.9 oz)</p>

Follow us on twitter: @KeonnTech

# AdvanReader-150™

## 2 or 4-port RFID UHF reader with on-board computer and open Linux OS



Mechanical specifications of AdvanReader-150 with 2 ports:

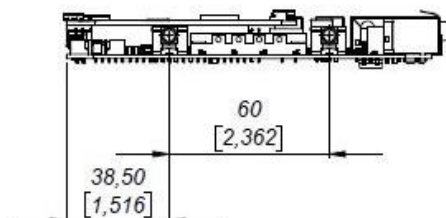
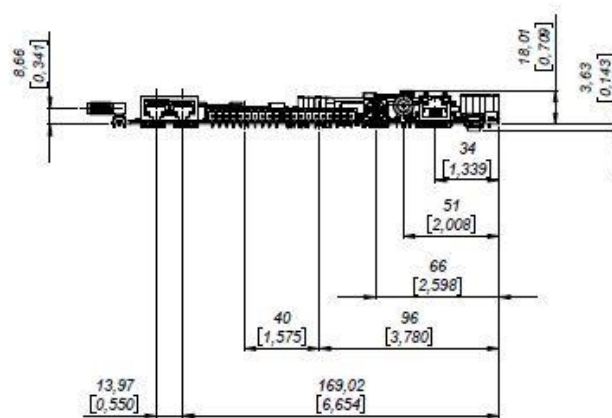
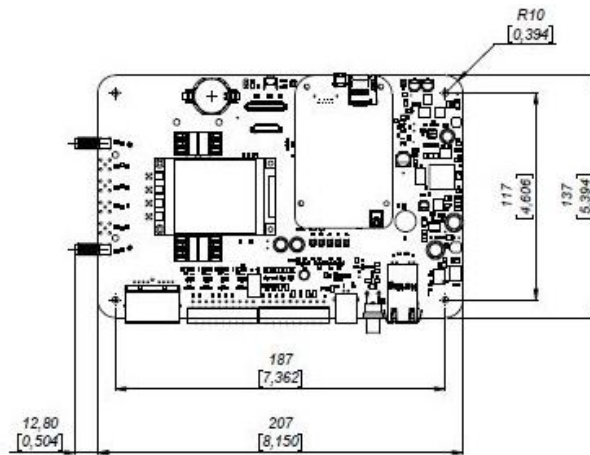
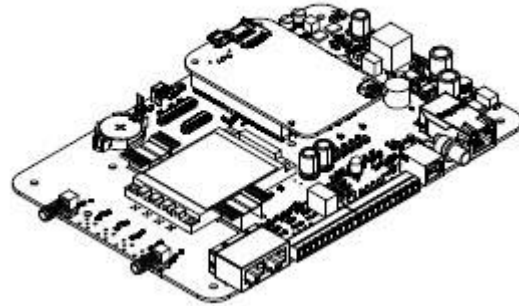

Units in millimeters and [inches]

Follow us on twitter: @KeonnTech

# AdvanReader-150™

## 2 or 4-port RFID UHF reader with on-board computer and open Linux OS



### Mechanical specifications of AdvanReader-150 with 2 ports:

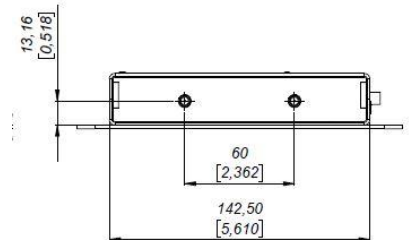
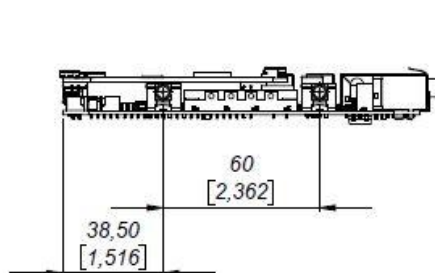
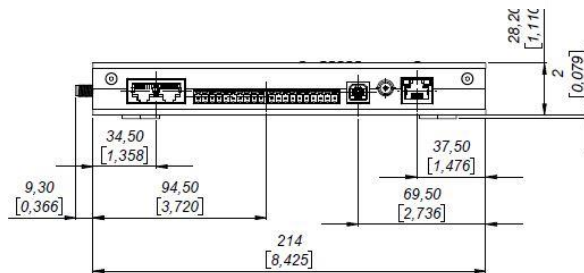
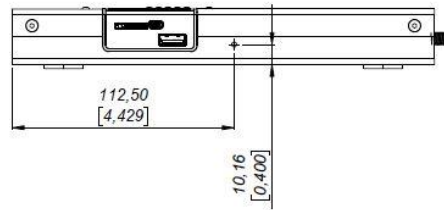
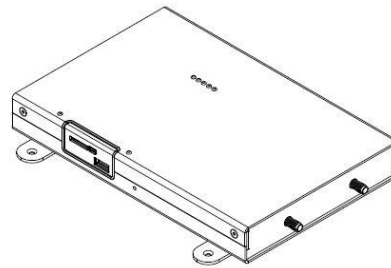
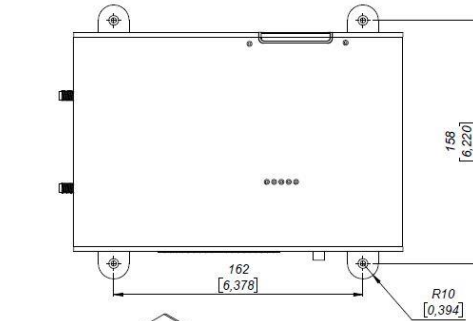

Units in millimeters and [inches]

# AdvanReader-150™

## 2 or 4-port RFID UHF reader with on-board computer and open Linux OS



### Mechanical specifications of AdvanReader-150 with 4 ports:

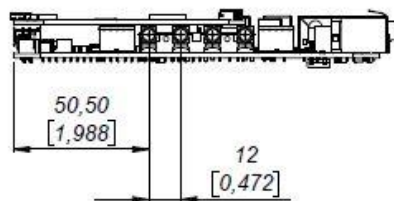
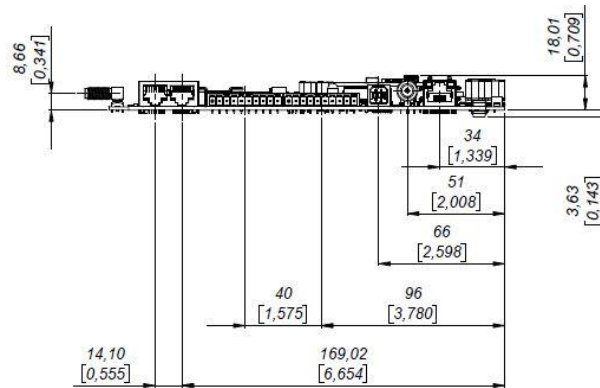
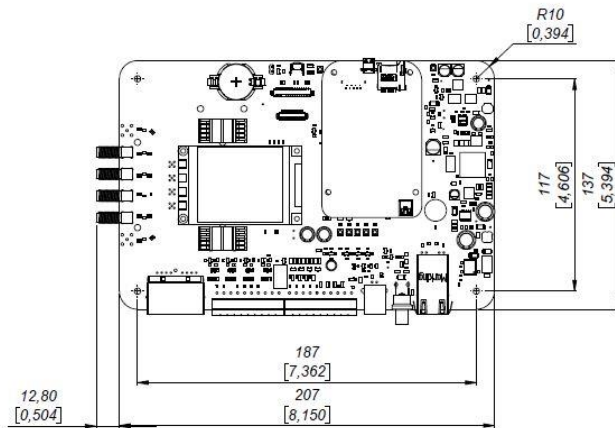
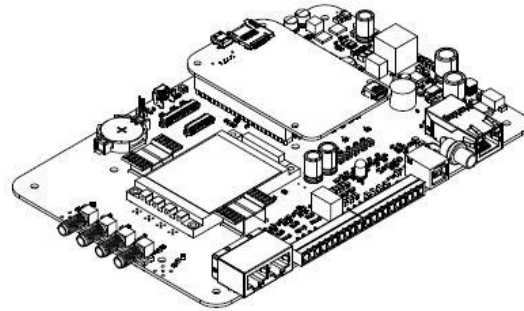

Units in millimeters and [inches]

# AdvanReader-150™

## 2 or 4-port RFID UHF reader with on-board computer and open Linux OS



### Mechanical specifications of AdvanReader-150 with 4 ports:

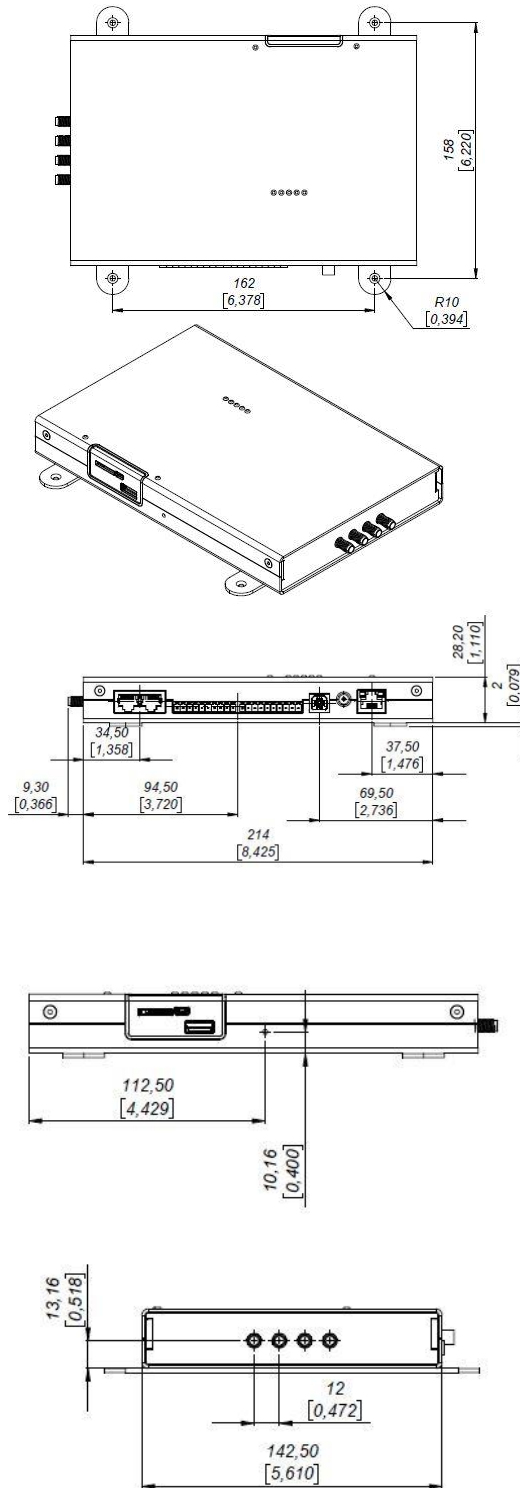

Units in millimeters and [inches]

Follow us on twitter: @KeonnTech

# AdvanReader-150™

## 2 or 4-port RFID UHF reader with on-board computer and open Linux OS



### Product codes for ordering

ADRD	-	mx	-	e	CT	-	FF	-	sc	
										<b>mx = number of ports</b>
		m2								2 ports
		m4								4 ports
										<b>e = enclosure</b>
				-						without enclosure
				e						with enclosure
										<b>CT = connector type</b>
					SMA					SMA Straight PCB mount
										<b>FF = frequency band</b>
							-			EU (865,6 MHz - 867,6 MHz) or US (902,0 MHz - 928,0 Mhz)
							CH			China (920 MHz - 925 MHz)
										<b>sc = series code</b>
									150	Series 150

Examples:

- **ADRD-m2-SMA-150:**
  - Advanreader
  - With 2 ports
  - Without enclosure
  - SMA connector type
  - EU/US frequency band
  - Model **150**
- **ADRD-m4-eSMA-CH-150:**
  - Advanreader
  - With 4 ports
  - With enclosure
  - SMA connector type
  - China frequency band
  - Model **150**

Keonn Technologies S.L.  
Pere IV, 78-84, planta 6, 3a  
08005 Barcelona, Spain

Tel: +34 931 814 477  
info@keonn.com  
www.keonn.com

Copyright © Keonn Technologies S.L.  
All rights reserved.  
Information in this publication supersedes all  
earlier versions. Specifications subject to change  
without notice.

Units in millimeters and [inches]

Follow us on twitter: @KeonnTech